

THE NEW ŠKODA

RAPID



ŠKODA
SIMPLY CLEVER



INTRODUCTION ₄
EXTERIOR DESIGN ₆
INTERIOR DESIGN ₁₀
CONNECTIVITY ₁₄
SIMPLY CLEVER ₂₀
COMFORT ₂₆
SAFETY ₃₀
PERFORMANCE ₃₄
MONTE CARLO ₃₈
SPORT PACKAGE ₄₂
CUSTOMISATION ₄₆
ACCESSORIES ₅₈
TECHNICAL SPECIFICATIONS ₆₂



A NEW EXPRESSION OF SPACE

Space isn't just a shape or dimension. It's an emotion that comes to life inside the new ŠKODA RAPID SPACEBACK. With its dynamic styling and signature sloping roof, the car lends character to anyone willing to grab it by its steering wheel. Its boyish charm is complemented by mature technology often found in cars of a higher class. Whether it's the latest connectivity features, safety systems or Simply Clever traits, there is plenty inside this car to make every journey as grand as your ambitions.

The RAPID SPACEBACK is yet another example of our philosophy of making beautifully designed cars that are as much a joy to drive now as they were back when we started.

That's Simply Clever. That's ŠKODA.



EXTERIOR DESIGN



SPREAD SOME BEAUTY

Good design is appreciated. Great design is shared. With its sharp, angular aesthetics and one-of-a-kind styling, the RAPID SPACEBACK is an attractive proposition for anyone.



SIDE-VIEW MIRRORS

The side indicators, placed in the external side-view mirror caps, represent an attractive as well as highly functional detail.

FRONT VIEW

The front grille is neatly incorporated between the headlamps. The wide air intake grid, with integrated fog lamps as well as a striking chrome strip, feature at the front of the car. The top package includes Bi-Xenon headlamps with LED daytime running lights.



SIDE VIEW

Thanks to the black B and C-columns, the glazed area of the side windows appears uniform and suggests a large interior space. SunSet tinted windows underscore the elegance of the exterior and protect rear passengers from the glare of the sun.



REAR LIGHTS

The car offers the familiar C-shaped illumination, which is a typical feature of the ŠKODA brand.

PANORAMIC ROOF

The sporty style of the RAPID SPACEBACK can be highlighted by the panoramic roof made entirely of tinted glass and rear glass extended over the 5th door.



INTERIOR DESIGN

FULLY FURNISHED

Space gets a beautiful makeover inside the RAPID SPACEBACK. A refined yet uncluttered dashboard means that everything is in the right place and there is a place for everything.



AMBIENT LIGHTING

Soft ambient lighting, including illumination on the door handles, makes the interior more cosy and comfortable.



DASHBOARD

Form follows function. The stylish instrument panel is easy to read and all the controls on the elegant dashboard and the driver's door are arranged practically. The top package includes a multifunctional leather steering wheel, which enables you to control the radio and phone.



UPHOLSTERY AND DÉCOR

Choose the interior that accentuates your driving pleasure. There are plenty of combinations of top-quality upholstery and décor, which can be enjoyed inside the generous interior space.



HEATED SEATS

In cold weather, your friends and family will appreciate the heated rear seats, which are regulated by a separate control on the rear side of the front armrest.



CONNECTIVITY

STAY TUNED STAY IN TUNE

Your car is the hub for all things work or play. The infotainment systems bring top-level connectivity so you can enjoy the best functions of your mobile devices on the go.



AMUNDSEN

The Amundsen navigation system, controlled via a 6.5" touch-screen display, has two SD card slots and comes with an SD card pre-installed with maps. It is further equipped with a USB/Aux-in input jack and all the standard functions of a top-class radio, including the ŠKODA Surround sound system and Bluetooth. The devices can be used to control the car menu. SmartLink+ and DAB (Digital Audio Broadcast) are available as an option.



ŠKODA SURROUND

Turn your car into an amphitheatre. Developed in collaboration with a leading audio brand, the ŠKODA Surround sound system employs six speakers. Special software can additionally employ two virtual speakers in the front and rear. The system can also create a virtual yet impressive subwoofer.



SMARTLINK+

With the SmartLink+ system (ŠKODA Connectivity bundle supporting MirrorLink®, Apple CarPlay and Android Auto), the car's infotainment system enables the driver to safely use the phone while driving. Plus, all installed applications that are certified as safe for vehicles are compatible with MirrorLink®, Apple CarPlay or Android Auto. The SmartLink+ system also includes the SmartGate function. It enables you to connect your smartphone to the car via cable to access interesting data about your drive, like driving economy, driving dynamics or service information.*



MyŠKODA APP

Meet Paul, the interactive assistant of the MyŠKODA App (for Android and iOS

systems), who can provide help in various daily situations. You can use him to access information about your car or for a complete description of what controls what, what each warning lamp means, etc. Paul can also keep an eye on the dates in your planner. Not only will you never forget a meeting, but your assistant will also advise you on how to get there.

* Visit our website for usage terms and compatibility information for SmartLink+.

**SIMPLY
CLEVER**



EVERYONE'S GOT SECRETS

Everywhere you look, there are little and big thoughtful features neatly tucked away, ready to be used whenever you need them. This is what makes every thrilling journey that much more ingenious.



GLOVE COMPARTMENT

Thanks to the closed storage compartment in the lower part of the dashboard by the front passenger, which can be air-conditioned, you have a place to store your drinks, keeping them refreshingly chilled during your trip.

TICKET HOLDER

When you need to display a parking ticket in a visible place, the solution is simple. The car is equipped with a parking ticket holder under the windscreen.



UMBRELLA BOX

A box with the original ŠKODA umbrella can be found under the front passenger seat.



ARMREST

The rear seat armrest with an integrated holder for two drinks gives rear seat passengers the opportunity to enjoy the ride with refreshments.



REFLECTIVE VEST COMPARTMENT

A special pocket for a reflective vest is located under the driver's seat, ensuring it's within easy reach if you need it.

ELASTIC SPACE

Space expands. It does so even inside the boot of the RAPID SPACEBACK. There are many options to fold, stretch, pull and hang that make the car adapt to your needs.



CAPACITY

The luggage compartment capacity of 415 litres, and 1,381 litres after folding down the rear seats, puts the car at the top of its class. If necessary, you can fold down one or two backrests and get more storage space, while still providing seating in the rear.



CARGO ELEMENTS

Any undesired movement of luggage while driving can be avoided with cargo elements. These are two plastic parts with a Velcro fastener, which can otherwise be stored in the compartments behind the rear wheel arches.

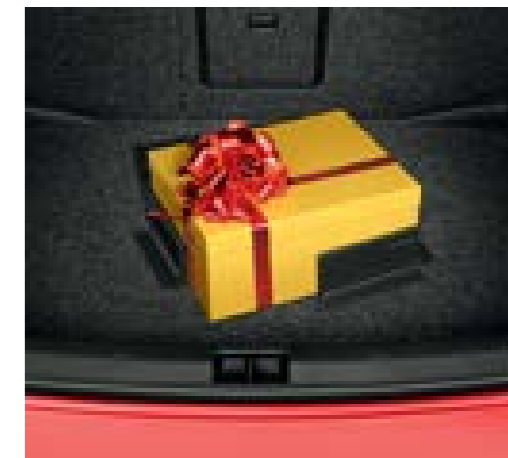

PRACTICAL OPENING

In vehicles with the foldable rear seat armrest, you can create an opening between the passenger and luggage compartments, while still retaining seating in the rear.



NET PROGRAMME

A set of nets reliably prevents your items from moving around. Plus you're able to clearly see where you put things.



COMFORT

TRAVEL COMFORT CLASS

Driving pleasure isn't all about speedy thrills. It's about the little comforts that add up in a big way, making even the daily commute far more comfortable for every driver.



KESY
The car can be equipped with KESY (Keyless Entry, Start and exit System) or with the simpler version called Easy Start. A Start/Stop button for keyless switching on and off of the engine is located on the steering column.

STEERING WHEEL
The multifunctional leather steering wheel lets you control the radio and phone.



CRUISE CONTROL
In addition to maintaining the preselected speed, cruise control enables you to increase or reduce speed without using the pedals.



HEADLAMP WASHERS
The integrated telescopic washers keep the headlamps perfectly clean.



SAFETY

WE'VE GOT YOUR BACK

True safety exists when you no longer have to think about it. That's why the RAPID SPACEBACK is equipped with plenty of safety and assistant systems that watch over you and your loved ones.



REAR-VIEW CAMERA

Located on the 5th door handle, this camera monitors the space behind the car and indicates driving lanes, based on the vehicle width. Integrated washers improve the camera's functionality.



FRONT ASSIST

Using a radar in the front bumper, Front Assist monitors the distance from the vehicle ahead and responds with an audio/visual signal, using Maxi DOT, to warn about an impending collision. If the driver fails to respond, the system initiates braking to minimise any possible impact.



DRIVER ALERT

This clever assistant system evaluates data from the power steering sensors to detect any driver fatigue behaviour. In such cases, the Maxi DOT display warns the driver to take a break.



AIRBAGS

Besides the front and front side airbags, the head airbags, which create a wall when activated, protect passengers from potential injuries.

PERFORMANCE



POWER YOUR EVERYDAY

A convincing performance is one where you never lack power when you need it. A range of powerful and economical engines will meet the diverse expectations of every driver.

PETROL ENGINES

All petrol engines feature TSI technology, which gives them a dynamic character. You can choose from 70 kW or 92 kW.



TRANSMISSIONS

If you enjoy absolute power in absolute comfort, there's an automatic 7-speed DSG (Direct Shift Gearbox) transmission.



START-STOP

This system saves fuel by automatically switching off the engine when idle, for example while waiting at the traffic lights or when moving slowly in a queue. By pressing the clutch pedal, the engine restarts automatically. Engine load reduction and more economical running are further assisted by the energy recovery functionality, which enables the effective use of the car's kinetic energy for battery recharging.



SPORT PACKAGE

SPORTY AT HEART

Being active means being alive. The RAPID SPACEBACK with Sport package inspires an active lifestyle for anyone. Whether it's a daily commute or weekend trip, a more stylish car makes any activity more enjoyable.



DOOR SILL STRIPS
The Sport package also includes distinctive door sill strips with the ŠKODA inscription.

FRONT VIEW
The RAPID SPACEBACK equipped with the Sport package features black elements such as the front grille frame and external side-view mirror covers.

FURTHER SPECIFIC FEATURES

The sporty style is accompanied by elegance. While the 5th door spoiler is supplied in the body colour, the diffuser comes in black. An attractive black ceiling awaits you inside.



CUSTOMISATION



ACTIVE

The standard equipment of the Active version includes external side-view mirrors and door handles in black, tinted windows, darkened rear lights, a central locking system, electrically-controlled front windows, and more.



ACTIVE BLACK INTERIOR
Fabric upholstery



ACTIVE BLACK INTERIOR
Fabric upholstery

AMBITION

The standard equipment of the Ambition version includes external side-view mirrors (electrically-adjustable and heated) and door handles in the body colour, headlamps with LED daytime running lights, remote controlled central locking, manual air-conditioning, a height-adjustable driver seat, an umbrella under the passenger seat, a sunglasses compartment, 12 V socket in the luggage compartment, and more.



AMBITION BLUE INTERIOR
Cool Brushed décor
Fabric upholstery



AMBITION BLUE INTERIOR
Cool Brushed décor
Fabric upholstery



AMBITION BLACK INTERIOR
Dark Brushed décor
Fabric upholstery



AMBITION BLACK INTERIOR
Cool Brushed décor
Fabric/leather upholstery

STYLE

The standard equipment of the Style version includes a chrome stripe in the front bumper, rear glass extended over the 5th door, interior decorative elements in chrome, the small leather package (steering wheel, gear stick knob and sleeve, handbrake handle), electrically-controlled front and rear windows, Maxi DOT, Radio Blues, and more.



STYLE BEIGE INTERIOR
Piano Black décor
Fabric upholstery



STYLE BLACK INTERIOR
Piano Black décor
Fabric upholstery



STYLE BLACK INTERIOR
Piano Black décor
Fabric/leather upholstery (as an option)



STYLE BEIGE INTERIOR
Piano Black décor
Fabric/leather upholstery (as an option)

DYNAMIC

The Dynamic interior, available for the Ambition and Style versions, features sports seats, the small leather package and the stainless steel foot pedal covers.



DYNAMIC INTERIOR
Piano Black décor
Dark Brushed décor (as an option)
Sports seats



DYNAMIC INTERIOR
Piano Black décor
Dark Brushed décor (as an option)
Sports seats

UPHOLSTERY

Active Black (fabric)



Beige (fabric/leather) – Style*



Black (fabric/leather) – Ambition*, Style*



Dynamic (sports seats, black fabric) – Ambition*, Style*



Customisation

Ambition/Style Blue (fabric)



Ambition Black (fabric)

Style Beige (beige-black fabric)



Style Black (fabric)

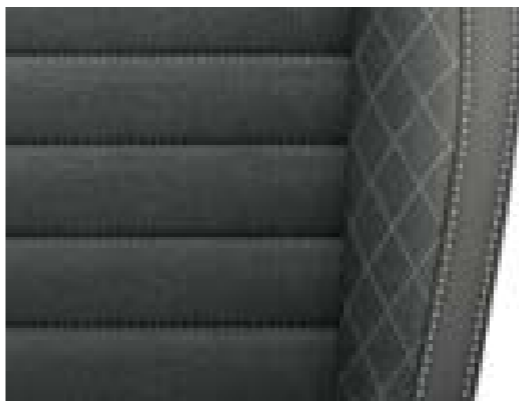

* Extra equipment.

Customisation

COLOURS



CANDY WHITE UNI



LASER WHITE UNI



MOON WHITE METALLIC



BRILLIANT SILVER METALLIC



CAPPUCCINO BEIGE METALLIC



QUARTZ GREY METALLIC

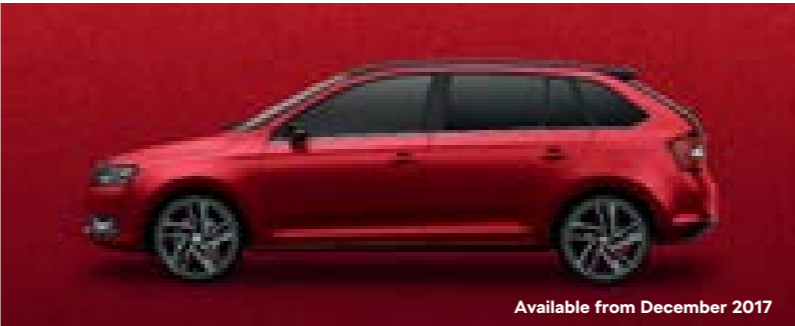

Available from December 2017

VELVET RED METALLIC



RALLYE GREEN METALLIC



PACIFIC BLUE UNI

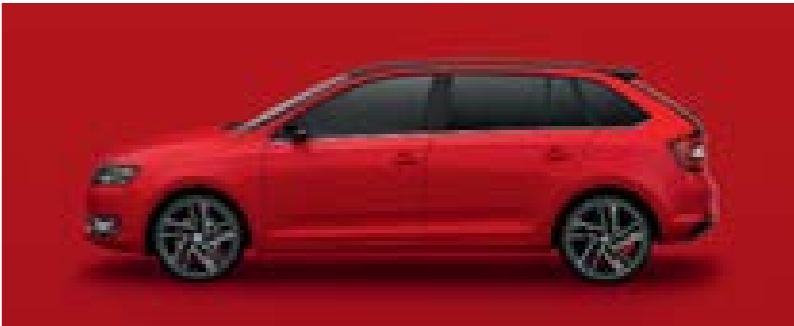

CORRIDA RED UNI



DENIM BLUE METALLIC



RACE BLUE METALLIC



MAPLE BROWN METALLIC



MAGIC BLACK METALLIC

WHEELS

14" steel wheels with FLAIR hub covers



15" steel wheels with COSTA hub covers



15" steel wheels with DENTRO hub covers



15" MATONE alloy wheels



16" VIGO black alloy wheels



16" ITALIA alloy wheels*



17" TORINO black alloy wheels*



17" SAVIO glossy black alloy wheels**



15" MATONE black alloy wheels



15" MATO alloy wheels



16" EVORA alloy wheels



16" VIGO silver alloy wheels



17" CAMELOT alloy wheels



17" BLADE black polished alloy wheels**



17" TRIUS alloy wheels



* Available exclusively for the Monte Carlo version.
 ** Available exclusively as part of the Emotion pack.

A top-down view of various travel accessories arranged on a light-colored wooden plank surface. On the left side, there is a stack of a wide-brimmed straw hat with a black band, a pair of white canvas sneakers, and a pair of blue denim jeans. In the center and right, there is a black camera with a lens cap, a pair of white sunglasses with dark lenses, a set of keys on a black cord, a round analog watch with a brown leather strap, a gold-colored pocket compass, and a coiled red and white striped cord. A large, semi-transparent white and orange diagonal graphic element is overlaid on the right side of the image.

ACCESSORIES

TAKE YOUR CAR SHOPPING

No two RAPID SPACEBACKs need to be the same. ŠKODA Original Accessories can transform your car by expanding its practicality, safety and purpose, depending on what you have planned for it.



DOG SAFETY BELT

If one of your usual passengers is a dog, we recommend equipping your car with a special safety belt (size S–XL).



BACK SEAT PROTECTION

This practical cover saves the interior of your car from getting dirty or damaged.



NET PROGRAMME

Providing a very attractive and practical accessory, this set of nets in red reliably prevents luggage and other items moving around in the luggage compartment.



NET UNDER THE PARCEL SHELF

This net is not only a suitable storage place for an umbrella, but also for anything you may want to keep separate from the rest of your luggage.



DECORATIVE VALVE CAPS

With the tyre valve caps bearing the ŠKODA logo, your car will look stylish down to the smallest detail.

TECHNICAL SPECIFICATIONS	1.0 TSI/70 kW	1.0 TSI/70 kW	1.0 TSI/81 kW	1.4 TSI/92 kW	1.4 TDI/66 kW	1.4 TDI/66 kW	1.6 TDI/85 kW
	Turbocharged petrol engine, direct injection system	Turbocharged petrol engine, direct injection system	Turbocharged petrol engine, direct injection system	Turbocharged petrol engine, direct injection system	Turbocharged diesel engine with common rail system	Turbocharged diesel engine with common rail system	Turbocharged diesel engine with common rail system
ENGINE							
Cylinders/Cubic capacity (cc)	3/999	3/999	3/999	4/1,395	3/1,422	3/1,422	4/1,596
Max. performance/Revs (kW/min ⁻¹)	70/5,000–5,500	70/5,000–5,500	81/5,000–5,500	92/5,000–6,000	66/3,000–3,250	66/3,000–3,250	85/3,500–4,000
Max. torque/Revs (Nm/min ⁻¹)	160/1,500–3,500	160/1,500–3,500	200/2,000–3,500	200/1,400–4,000	230/1,750–2,500	230/1,750–2,500	250/1,500–3,000
Air pollution regulation	EU6	EU6	EU6	EU6	EU6	EU6	EU6
Fuel	Petrol, RON min. 95	Petrol, RON min. 95	Petrol, RON min. 95	Petrol, RON min. 95	Diesel	Diesel	Diesel
PERFORMANCE							
Maximum speed (km/h)	184	186	198	205	183	183	198
Acceleration 0–100 km/h (s)	11.0	11.3	9.8	8.9	11.6	11.7	9.9
Fuel consumption 99/100 (l/100 km)							
– urban	5.4/5.2*	5.5/5.4*	5.5/5.4*	6.2/6.1*	4.4/4.3*	4.5/4.4*	4.7/4.6*
– extra-urban	4.0/3.9*	4.1/4.0*	4.0/3.9*	4.2/4.1*	3.7/3.6*	3.8/3.7*	4.0/3.9*
– combined	4.5/4.4*	4.6/4.5*	4.6/4.5*	4.9/4.8*	4.0/3.9*	4.0/3.9*	4.2/4.1*
CO ₂ emissions (g/km)	103/101*	107/105*	106/104*	115/113*	105/103*	106/104*	109/107*
Turning circle diameter (m)	10.9	10.9	10.9	10.9	10.9	10.9	10.9
POWER TRANSMISSION							
Type	Front-wheel drive	Front-wheel drive	Front-wheel drive	Front-wheel drive	Front-wheel drive	Front-wheel drive	Front-wheel drive
Clutch	Hydraulic single-disc clutch	Twin coaxial clutch, electro-hydraulically operated	Hydraulic single-disc clutch	Twin coaxial clutch, electro-hydraulically operated	Hydraulic single-disc clutch	Twin coaxial clutch, electro-hydraulically operated	Hydraulic single-disc clutch
Transmission	Manual 5-speed	Automatic 7-speed DSG	Manual 6-speed	Automatic 7-speed DSG	Manual 5-speed	Automatic 7-speed DSG	Manual 5-speed
WEIGHT							
Kerb weight – in standard version with 75 kg driver (kg)	1,165	1,199	1,185	1,231	1,239	1,260	1,290
Payload – incl. driver and extra equipment (kg)	535	535	535	535	535	535	535
Total weight (kg)	1,625	1,659	1,645	1,691	1,699	1,720	1,750
Trailer load without brakes (max. kg)	580	590	590	610	610	620	640
Trailer load with brakes – 12% (max. kg)	1,000	1,000	1,100	1,200	1,000	1,000	1,200
Tank capacity (l)	55	55	55	55	55	55	55

* Applies to vehicles with 185/60 R15 tyres with low rolling resistance.

** The car can be equipped with a set of all-season tyres. For more information contact your authorised ŠKODA partner.

The listed values (except for values marked *) apply to the standard model without extra equipment. All engines feature the Start-Stop system and energy recovery functionality.

FURTHER SPECIFICATIONS

Body	Exterior dimensions
Type	5-seater, 5-door, 2-compartment
Drag coefficient C _w	0.306–0.309 (according to engine version)
Chassis	
Front axle	McPherson suspension with lower triangular links and torsion stabiliser
Rear axle	Compound link crank-axle
Braking system	Hydraulic dual-diagonal circuit braking system vacuum assisted
– front brakes	Disc brakes with inner cooling and with single-piston floating calliper
– rear brakes	Drum brakes; alternatively disc brakes depending on the engine version
Steering	Direct rack-and-pinion steering with electromechanical power steering
Wheels	5.0J x 14", 6.0J x 15"
Tyres**	175/70 R14; 185/60 R15
Exterior dimensions	
Length/width (mm)	4,304/1,706
Height (mm)	1,459
Wheel base (mm)	2,602
Track front/rear (mm) – according to engine version	1,463; 1,457/1,500; 1,494
Clearance (mm)	134
Interior dimensions	
Lateral room front/rear (mm)	1,418/1,428
Effective head room front/rear (mm)	1,014/980
Luggage storage space (max. l)	
Without spare tyre, with rear seat backrests	
– upright/down	415/1,381

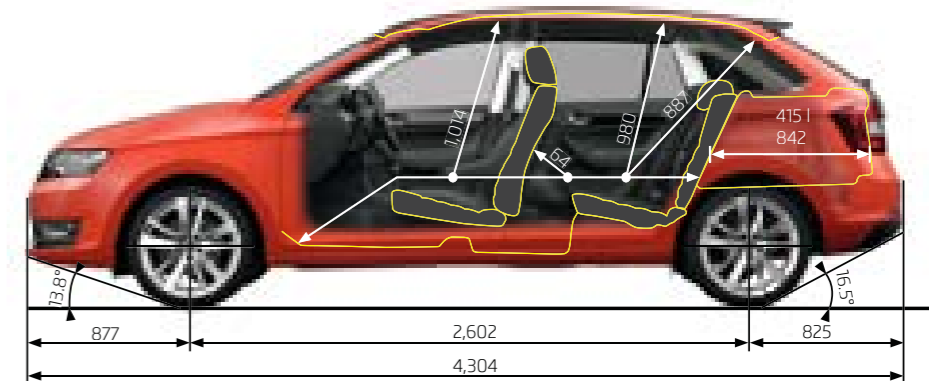
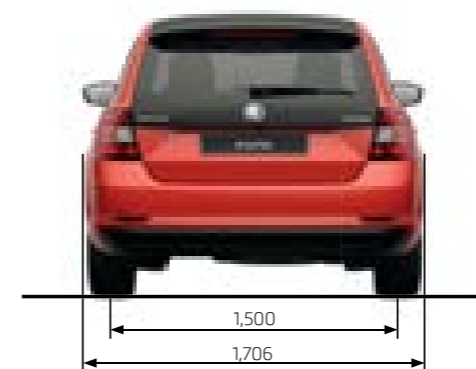
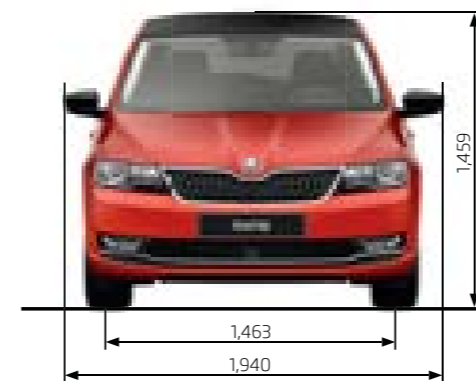

IMAGE DISCLAIMER

The images presented in this catalogue (brochure) are used for illustrative purposes only and are not intended to form part of any contract or warranty. They display pre-series cars and certain illustrations, features, parts and equipment may differ from the actual production cars and from country to country. To get the exact specification of features, parts and equipment, please get in touch with your nearest local ŠKODA dealer.



MyŠKODA App

Get your very own personal digital companion. Download MyŠKODA featuring PAUL, an interactive assistant who's there to help you, not only with watching over your car, but also with managing your day.



ŠKODA Connect App

Enjoy full control of your car. Download ŠKODA Connect and access all necessary features anytime, whether it's driving data, fuel range, planning a route or even where you last parked.

**IF YOU'VE ENJOYED READING ABOUT IT
— IMAGINE DRIVING IT**

CALL US TO ARRANGE A TEST DRIVE

R20220 11/17

Your ŠKODA partner: